

Installation Instructions ProSpex Plus Trimless Kit

Instructions applicable for the following luminaires:
 090+xx-TL, 093+xx-TL, 090+xx-TL-WW, 090+13-xx-TL, 093+13-xx-TL
 (xx = lamp type MR = QR-CBC51 low voltage, MH = CMH-MR16/CDM-Rm metal halide
 LED = ProSpex LED50, **XIC** = Xicato LED module)

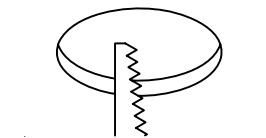

Cut hole as follows:
ProSpex + TL or TR
102mmØ

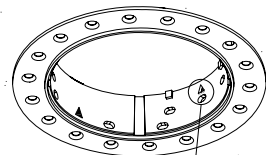

Fit the installation collar and fix to plasterboard with suitable screws (drywall screws for example).

(Tip - for additional strength bond ring into the hole).

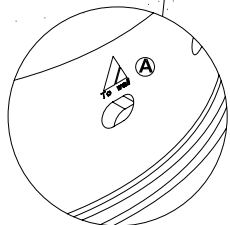
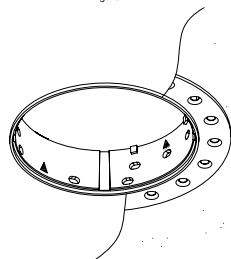
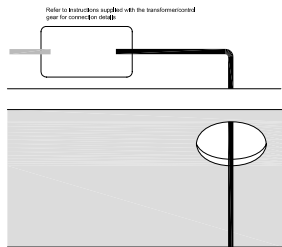

Figure 1

For Wallwashers, ensure the marking "To wall" is aligned to the surface to be illuminated (figure 1 marked A).



Skim plaster to the lip edge of the plaster ring. Make good and paint ceiling before installing luminaire body.



Install control gear, transformer or driver through the installation ring.

Wire equipment according to the installation instructions provided/printed on the equipment to the socket(s)/terminals provided.

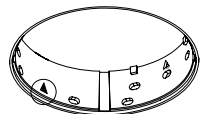

Frame is now installed ready for the luminaire insert.

Installation Instructions ProSpex Plus Trim Kit

Instructions applicable for the following luminaires:
 090+xx-TR, 093+xx-TR, 090+xx-TR-WW, 090+313-xx-TR, 093+33-xx-TR
 (xx = lamp type MR = QR-CBC51 low voltage, MH = CMH-MR16/CDM-Rm metal halide
 LED = ProSpex LED50, **XIC** = Xicato LED module)

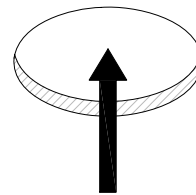

Make good and paint the ceiling prior to installing the installation kit.

To install the installation kit, depress the springs and install the kit into the cut-out, taking care not to damage the ceiling with the springs.

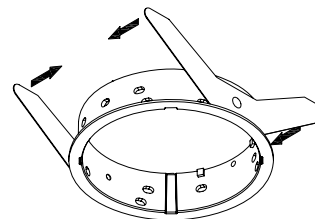

For Wallwashers, ensure the marking "To wall" is aligned to the surface to be illuminated (detail opposite).

Note The arrow marked B in figure 1.1 opposite indicates the keyed alignment for the adjustable mechanism.

Refer to instructions supplied with the transformer/control gear for correct fit details.

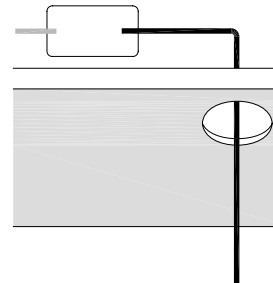

Install control gear, transformer or driver through the installation ring.

Wire equipment according to the installation instructions provided/printed on the equipment to the socket(s)/terminals provided.

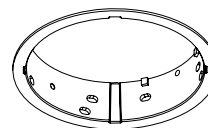

Frame is now installed ready for the luminaire insert.

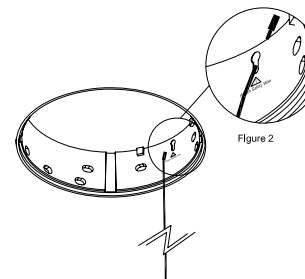

Figure 2

For all luminaire types, first attach the front plate safety wire.

In the ceiling trim there is a keyed hole, marked "Attach Safety Wire"

Pass the ferrule end of the wire through the wide hole.

Allow the wire to hang, the ferrule end will not pass through the narrower slot.

Installation Instructions ProSpex Plus Luminaire inserts.

Adjustable version

Instructions applicable for the following luminaires:

093+xx-TL - 093+13-xx-TL

093+xx-TR - 093+13-xx-TR

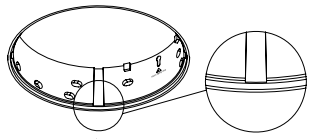

Wire the adjustable luminaire insert.

Install any accessories in the media holder and fit the lamp/LED module (see separate LED instruction sheet for LED module Installation instructions).

To install the adjustable insert locate the squared off slot in the ceiling trim (adjacent to the keyed hole for the safety wire) in figure 2.

Align the square lug on the luminaire insert with this slot and install (figure 3). The ball-catches will locate in the correct places and the lugs in the top of the trim will not allow the insert to be pushed too far in.

The insert is now installed and ready to be focused (see separate details on focusing the adjustable luminaire).

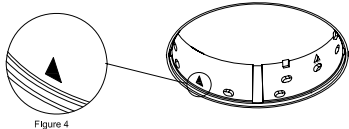
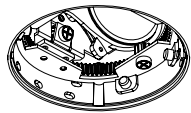
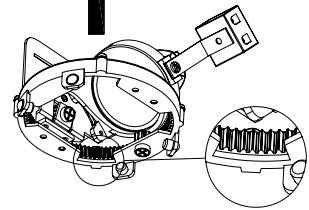

Figure 4

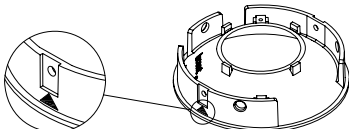

Figure 5

To install the front plate line up the solid triangle on the upstand of the front plate (figure 5) with the solid triangle on the inside of the ceiling trim (figure 4). Install the front plate, making sure the safety wire passes up through it's hole and the ball-catches locate correctly.

The luminaire is now installed and ready to use.



Trimless Conical

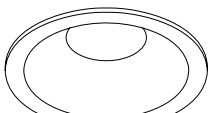

Conical With Trim

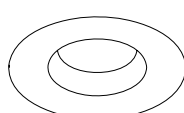

Trimless Flat Plate

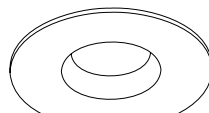

Flat Plate With Trim

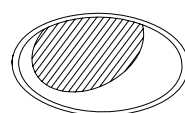

Trimless Wallwash

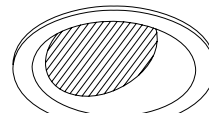

Wallwash With Trim

Wallwash version

Instructions applicable for the following luminaires:

090+xx-TL-WW - 090+xx-TR-WW

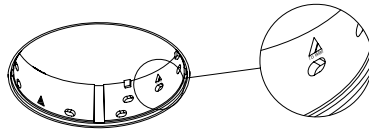

Wire the luminaire insert.

Install the lamp/LED module.

To install the wallwash insert 1st attach the fixture safety wire to the installation kit (as previous).

Align the "To Wall" marking on the upstand of the insert with the similar marking on the inside of the ceiling trim. Install the insert, making sure the safety wire passes up through it's hole and the ball-catches locate correctly.

The luminaire now is installed and ready to use.

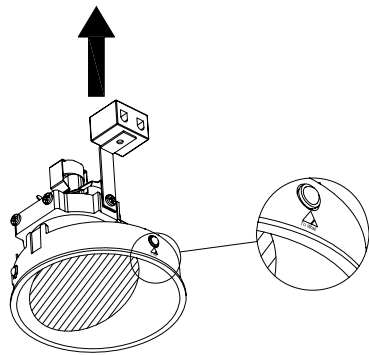

Fixed Version

Instructions applicable for the following luminaires:

090+xx-TL - 090+13-xx-TL

090+xx-TR - 090+13-xx-TR

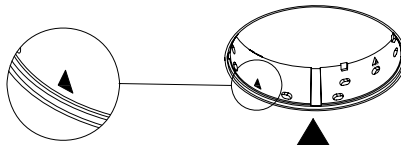

Wire the luminaire insert.

Install the lamp/LED module.

To install the fixed insert (Conical or Flat Plate types) 1st attach the fixture safety wire to the installation kit (as previous).

Align the solid triangle on the upstand of the insert with the solid triangle on the inside of the ceiling trim. Install the insert, making sure the safety wire passes up through it's hole and the ball-catches locate correctly.

The luminaire is now installed and ready to use.

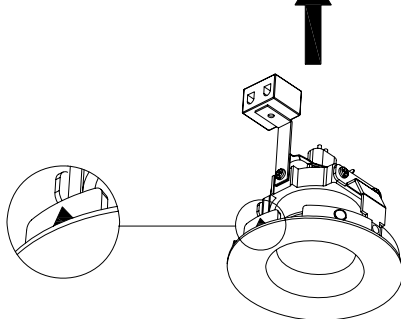

Focusing the adjustable insert.

Lucent ProSpex adjustable downlights are supplied with lockable tilt and rotation feature, allowing hot aiming using a screwdriver which simplifies focusing while the lamp is on.

The fixture remains locked in focus throughout the re-lamping process.

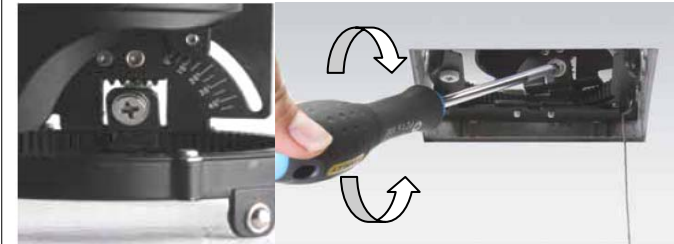

Gear driven rotation to 45°



90°

45°

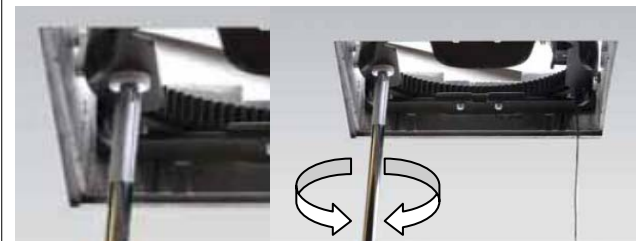

Gear driven rotation to 350°



0°

350°