

## InWall Vertical

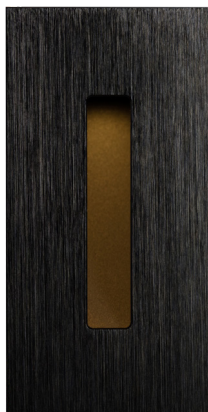

InWall provides fully recessed wall light for interior and exterior installation. InWall products are Wet rated and include round and square variants. Springs for hollow wall and tube for solid surfaces installation available. Available in 3 color temperatures. TRIAC/Phase, 0-10V/1-10V, DMX and DALI/digital dimming.

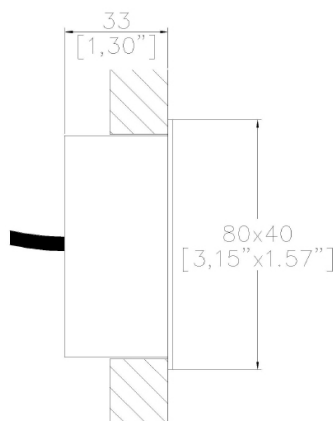

AIW4080

LED Source	LED
CCT	3000K
Drive Current	700mA
Power inc Driver	2.6W
Delivered Lumens	15
Delivered Intensity cd	57
Efficacy lm/w	6
Forward Volt	3V
CRI	≥90 CRI
Ingress Protection	IP66/67

Project Ref: \_\_\_\_\_

Location Ref: \_\_\_\_\_

Specify fixture part number (All boxes must be filled in to correctly order)

<b>AIW4080</b>					
<b>CCT</b>	_____				
<b>27</b>	2700K				
<b>30</b>	3000K				
<b>40</b>	4000K				
<b>Finish</b>	_____				
<b>BSS</b>	Brushed Stainless Steel				
<b>PSS</b>	Polished Stainless Steel				
<b>BRZ</b>	Flamed Bronze				
<b>ABZ</b>	Antique Bronze (Interior Only)				
<b>ASV</b>	Matt Silver (Interior Only)				
<b>ABK</b>	Matt Black				
<b>WH</b>	Matt RAL9016 White				
<b>Dimming Protocol<sup>^</sup></b>	_____				
<b>S</b>	Non-Dimmable				
<b>P</b>	TRIAC/Phase (120V ONLY) (25-10% Minimum Dimming) <sup>***</sup>				
<b>LP</b>	Lutron Forward Phase 2-Wire (1% Dimming) (120V ONLY)				
<b>ESS</b>	EcoSystem 5-Series (5% Dimming)				
<b>LHE</b>	EcoSystem Hi-Lume Fade to Black (1% Dimming)				
<b>LAE</b>	Lutron 3-Wire Hi-Lume (1% Dimming)				
<b>LHP</b>	Lutron Hi-Lume Premier EcoSystem (0.1% Dimming)				
<b>A</b>	0-10V (15-5% Minimum Dimming) <sup>***</sup>				
<b>ESD</b>	EldoLED Solo DALI2 (0.1% Dimming)				
<b>EED</b>	EldoLED Eco DALI2 (1% Dimming)				
<b>ESA</b>	EldoLED Solo 0-10V/1-10V (0.1% Dimming)				
<b>EEA</b>	EldoLED Eco 0-10V/1-10V (1% Dimming)				
<b>B</b>	Bluetooth <sup>**</sup>				
<b>Accessories</b>	_____				
<b>XX</b>	Not required				
<b>TH381</b>	IP68/Wet Connector				
<b>Installation Methods</b>	_____				
<b>IW4080-SPR</b>	Springs for Hollow Walls				
<b>IW4080-BOX</b>	Box for solid walls				
<b>IW4080-CONDUIT</b>	Conduit Box				

For exterior use an IP68/Wet connector is required.

<sup>^</sup>Not all power supplies are available for single connection, some require series connection with multiple fittings. Consult Lucent Lighting Inc for more information.

All Lucent InWall products are supplied as standard with 5ft (1.5m) lead

## Installation Methods:

### IW4080-SPR

For installation in hollow walls  
Cut out: 2.83" x 1.38" (72 x 35mm)

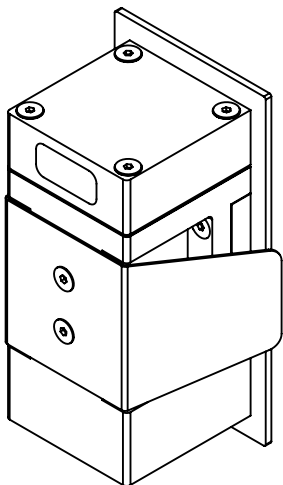

IW4080-SPR

### IW4080-BOX

For installation in solid surfaces

External connection only, for enclosed cable or conduit connection use IW4080-CONDUIT

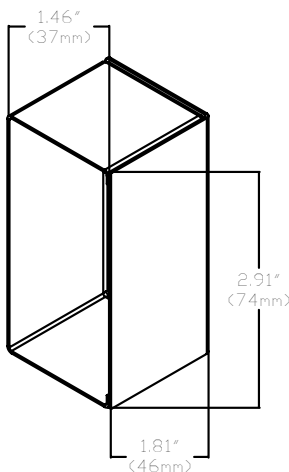

IW4080-BOX

### IW4080-CONDUIT

Installs behind wall, Conduit must be provided as per NEC/CEC requirements

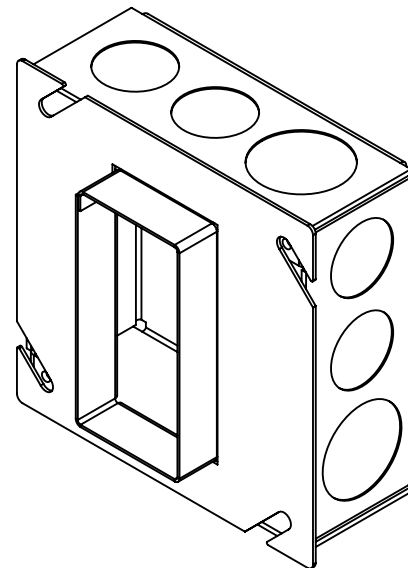

IW4080-CONDUIT

## Accessories:

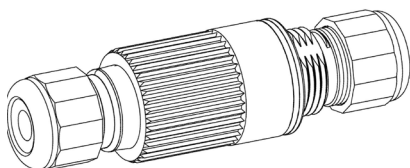

TH381 - IP68/Wet Connector

Please check suitability of installation method prior to purchase.  
This product must be installed in accordance with all local building codes.

.....  
Technical Details

\*Custom color requires a paint chip or RAL code and may increase price and lead-time

It is the responsibility of the specifier/integrator/installer to check and ensure compatibility of any control equipment used. Additional cabling may be required depending on the dimming protocol specified.

\*\*Bluetooth (wireless) is a communication protocol. The exact dimming protocol must be confirmed to allow the selection of suitable drivers or Bluetooth devices.

\*\*\*Non specific driver type, dimming performance depending on exact driver used. Contact Lucent Lighting for more information.

^ Depth indicated is the minimum recess depth for the luminaire with a remote mounted LED driver. Installing a driver through either the luminaire cut-out or installation kit may require additional recess depth, please refer to the relevant installation instructions prior to purchase.

First Fix Requirement. Luminaire comprised of fixture body with ceiling trim and installation kit, which is to be fitted into the ceiling once finished. Ensure correct alignment of the installation kit before final assembly (see luminaire installation instructions for details)

Location. Tested from underside of the ceiling.

Data correct at time of publishing. It is the policy of Lucent Lighting to continually review and improve its products and therefore reserve the right to change any details of product or withdraw specifications without prior notice.

This specification sheet supersedes all previous versions.

All intellectual property rights pertaining to the product described above and to this document are owned by or licensed to Lucent Lighting, Incorporated. Lucent Lighting reserves the right to take whatever action is necessary to protect its intellectual property, patents and trademarks

Please notify Lucent Lighting Inc. inaccuracies. E&OE  
.....



**Light efficiency:**

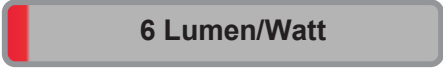

**Light quality:**



**Color temperature:**

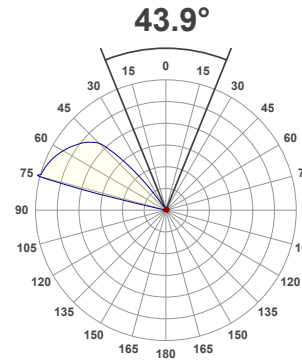

**Product name:**

**InWall Vertical, 3000K, 700mA**

**Item number:**

**IW4080-30-700mA**

**Delivered information for above fixture and LED combination.**

**Output: 15.4 Lumen Peak intensity: 56.7 cd Power consumption: 2.6**

**CRI R values**

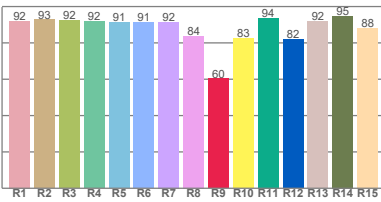

**TM30 C Values**

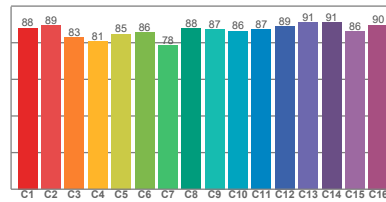

**Color vector graphics**

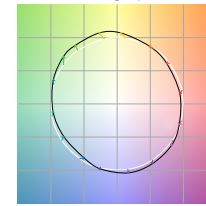

Color temperature	Color rendering index	Red component	Color fidelity	Color gamut	Color quality scale	Color coordinate cie 1931	Color coordinate cie 1931	Color coordinate	Color coordinate	Color deviation from black body
CCT	CRI	CRI R9	TM30 Rf	TM30 Rg	CQS	x	y	u	v	Δuv
3000 K	90.9	60.3	86.5	103.1	88.6	0.437	0.404	0.247	0.346	-0.0003

**Beam details**

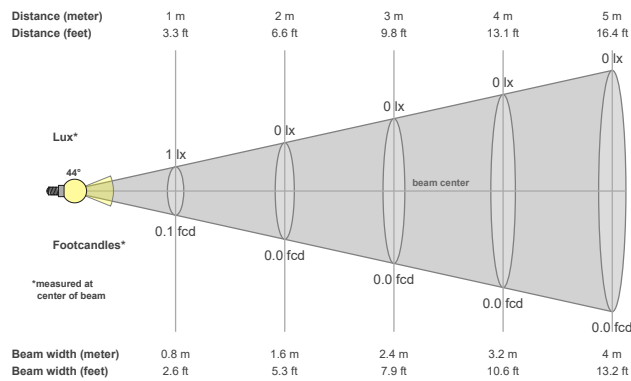

**Beam angles**

Beam angle 50%	Field angle 10%	Cutoff angle 2,5%
<b>43.9°</b>	<b>113.1°</b>	<b>147.6°</b>

**Beam intensities**

Peak intensity	Int. ratio in 120° cone	Int. ratio in 90° cone
<b>56.7 cd</b>	<b>60.4%</b>	<b>18.1%</b>

**Beam intensities from 1-20m**

1m	2m	3m	4m	5m	6m	7m	8m	9m	10m	11m	12m	13m	14m	15m	16m	17m	18m	19m	20m
3.3ft	6.6ft	9.8ft	13.1ft	16.4ft	19.7ft	23ft	26.2ft	29.5ft	32.8ft	36.1ft	39.4ft	42.7ft	45.9ft	49.2ft	52.5ft	55.8ft	59.1ft	62.3ft	65.6ft
1lx	0lx	0lx	0lx	0lx	0lx	0lx	0lx	0lx	0lx	0lx	0lx	0lx	0lx	0lx	0lx	0lx	0lx	0lx	0lx
0.1fcd	0fcd	0fcd	0fcd	0fcd	0fcd	0fcd	0fcd	0fcd	0fcd	0fcd	0fcd	0fcd	0fcd	0fcd	0fcd	0fcd	0fcd	0fcd	0fcd

The above information is for 3000K colour temperature, for specific module information please see LED spec located on our website

For information regarding other colour temperatures please use the following factors for lumen output and candelas:

2700K = 0.82

4000K = 1.11